



System
LFG



Trunking system available in heights   

-  Trunking
-  Divider
-  Fittings

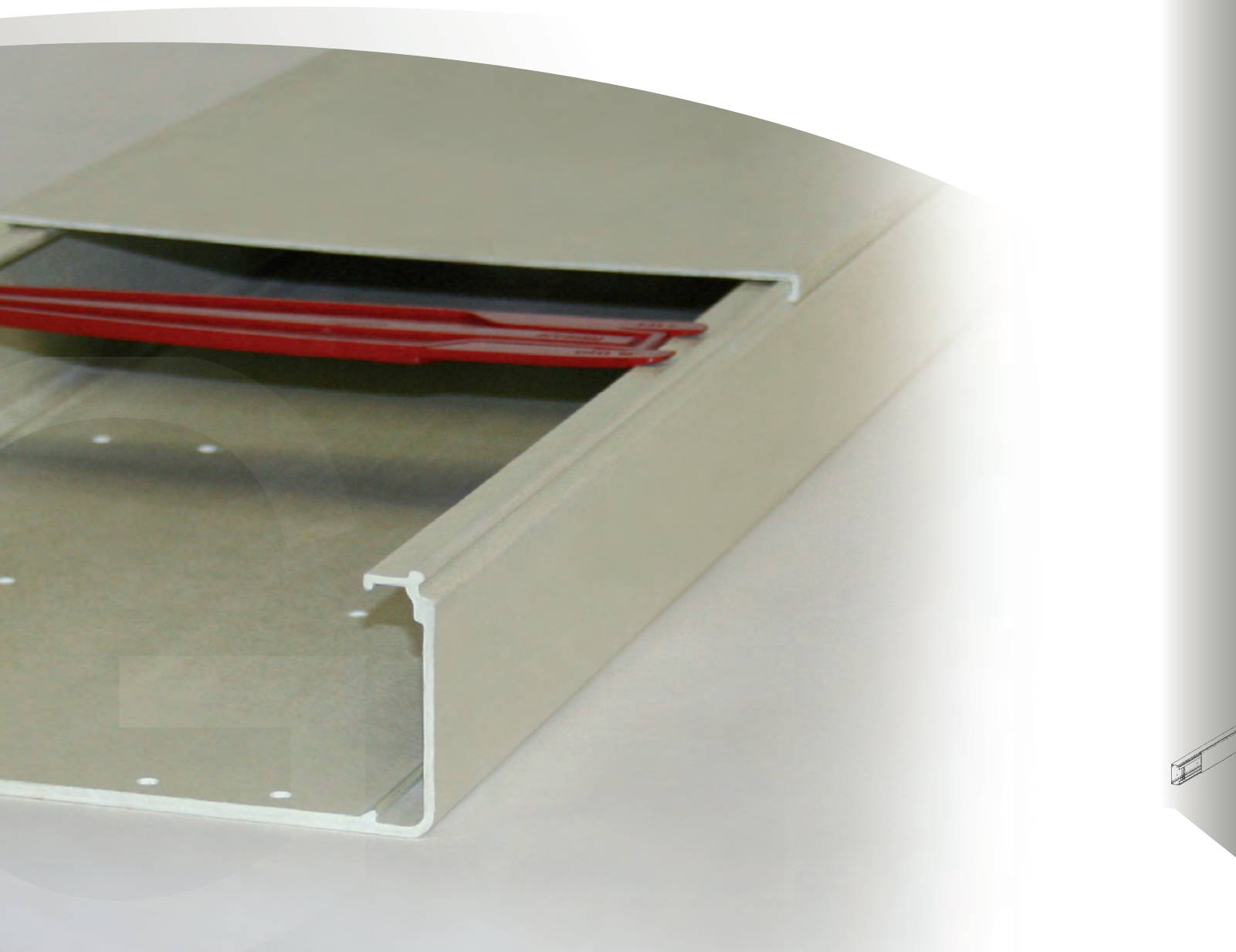































Especially used in extreme conditions trunking EBO Systems LFG in GRP is ideal in many areas such as industrial plants, factories, waste water treatment installations, refineries, offshore oil platforms, photovoltaic system, tunnels, building or food industry.

Large variations in temperature do not affect the mechanical properties of the trunking.

TRUNKING SYSTEM LFG

Available siderail heights   

SYSTEM	GRP-Trunking, pultruded	LFG	 103	 103	 103
ACCESSORIES	GRP-Splice plate with clip, pressed	KPGH 40	 103	 —	 —
	GRP-Splice plate with clip, pressed	KPGH 50	 —	 103	 —
	GRP-Splice plate with clip, pressed	KPGH 80	 —	 —	 103
	Clamp for cables holding	LFGKH	 103	 103	 103
	GRP-Endcap, pultruded	KPKE	 104	 104	 104
	GRP-Divider, pultruded	LFGT/...M	 —	 104	 104
	GRP-External elbow 90°, pultruded	LFGAC	 104	 104	 104
	GRP-Internal elbow 90°, pultruded	LFGIC	 104	 104	 104
	GRP-Horizontal elbow 90°, pultruded	LFGWC	 105	 105	 105

All trunkings and accessories are delivered with covers.

* suitable for all heights.

GRP trunking

pultruded, with cover, and cable fixing clamps

Item ref.	RAL colour	Height	Width B	Accessories/ bolts included	Material thickness (th) mm	EAN code	Weight 100 units m	Min. pack.
K23 LFG 40.060	7032	40	57	2 LFGKH 60	2,0	948567	92	2 m
K23 LFG 50.100	7032	50	100	2 LFGKH 100	2,5	948574	160	2 m
K23 LFG 50.150	7032	50	150	2 LFGKH 150	2,5	948581	205	2 m
K23 LFG 50.200	7032	50	200	2 LFGKH 200	2,5	948598	265	2 m
K23 LFG 80.100	7032	80	100	2 LFGKH 100	2,5	948604	205	2 m
K23 LFG 80.150	7032	80	150	2 LFGKH 150	2,5	948611	328	2 m
K23 LFG 80.200	7032	80	200	2 LFGKH 200	2,5	948628	424	2 m
K23 LFG 80.300	7032	80	300	2 LFGKH 300	3,2	948635	500	2 m

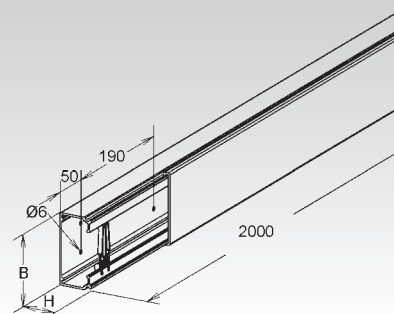

Clipsable splice plate

pressed, horizontal, fixing with bolts

Item ref.	RAL colour	Height	EAN code	Weight 100 units	Min. pack.
K23 KPGH 40	7032	25	955695	4,5	1 set

for the connection of cable trays and fittings H40, with splice plates H40

During the assembly, an expansion gap of 3 mm for dilatation must be considered.

Mounting accessories required : 2 bolts M6x20 V4A (to be ordered separately)

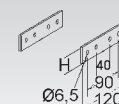

Clipsable splice plate

pultruded, horizontal

Item ref.	RAL colour	Height	EAN code	Weight 100 units	Min. pack.
K23 KPGH 50	7032	39	955701	6	1 set

for the connection of cable trays and fittings H50, with splice plates H50

During the assembly, an expansion gap of 3 mm is automatically taken in consideration.

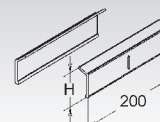

Clipsable splice plate

pultruded, horizontal

Item ref.	RAL colour	Height	EAN code	Weight 100 units	Min. pack.
K23 KPGH 80	7032	69	955718	22,5	1 set

for the connection of cable trays and the fittings H80, with splice plates H80 should be clipped on both cable trays sides.

Need: 2 pieces for each cut

During the assembly, an expansion gap of 3 mm for dilatation must be considered.

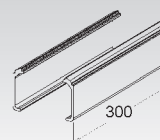

Hold down clamp for cables

Polyamid nylon

Item ref.	Width B	EAN code	Weight 100 units pc	Min. pack.
K13 LFGKH 60	38	948703	0,2	1 p.
K13 LFGKH 100	75	948710	0,6	1 p.
K13 LFGKH 150	125	948727	1,7	1 p.
K13 LFGKH 200	175	948734	17,0	1 p.
K13 LFGKH 300	275	948741	30,0	1 p.



TRUNKING SYSTEM LFG

End cap for cable tray

pultruded

Item ref.	RAL colour	Height mm	Width B mm	EAN code	Weight 100 units pc	Min. pack.
K23 KPKE 40.060	7032	40	60	955381	5,5	1 p.
K23 KPKE 50.100	7032	50	100	955398	6,0	1 p.
K23 KPKE 50.150	7032	50	150	955404	9,0	1 p.
K23 KPKE 50.200	7032	50	200	955411	10,0	1 p.
K23 KPKE 80.100	7032	80	100	955428	8,0	1 p.
K23 KPKE 80.150	7032	80	150	955435	11,0	1 p.
K23 KPKE 80.200	7032	80	200	955442	13,0	1 p.
K23 KPKE 80.300	7032	80	300	955459	20,0	1 p.

for the cable tray ends

Used for: Cable tray H50, H80, KP..., KPL... and cable trunking LFG...

Mounting accessories required : 2 bolts M6x16 V4A (to be ordered separately)

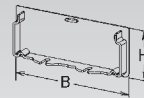

GRP separator

pultruded

Item ref.	RAL colour	Height mm	EAN code	Weight 100 units m	Min. pack.
K23 LFGT 50	7032	50	948659	31	2 m
K23 LFGT 50/M	7032	50	968343	31	1 m
K23 LFGT 80	7032	80	948666	42	2 m
K23 LFGT 80/M	7032	80	968350	42	1 m

Used for: trunking LFG

For a wall mounting or a ceiling mounting, the cable tray must not be in direct contact with the surface. The separator is supplied not mounted and must be fixed with bolts inside the cable tray, in its length at a specific distance from the cable tray side

Mounting accessories required : 1 bolt M6x20 V4A per meter (to be ordered separately)

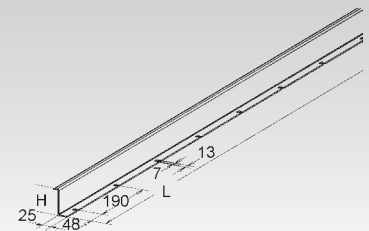

Vertical outside elbow 90°

pultruded, with cover

Item ref.	RAL colour	Height mm	Width B mm	EAN code	Weight 100 units pc	Min. pack.
K23 LFGAC 40.060	7032	40	60	948833	41	1 p.
K23 LFGAC 50.100	7032	50	100	948833	85	1 p.
K23 LFGAC 50.150	7032	50	150	948840	114	1 p.
K23 LFGAC 50.200	7032	50	200	948857	137	1 p.
K23 LFGAC 80.100	7032	80	100	948864	108	1 p.
K23 LFGAC 80.150	7032	80	150	948871	154	1 p.
K23 LFGAC 80.200	7032	80	200	948888	199	1 p.
K23 LFGAC 80.300	7032	80	300	948895	301	1 p.

Used for: trunking LFG

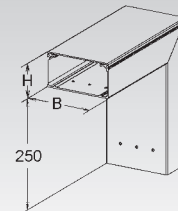

Vertical inside elbow 90°

pultruded, with cover

Item ref.	RAL colour	Height mm	Width B mm	EAN code	Weight 100 units pc/	Min. pack.
K23 LFGIC 40.060	7032	40	60	948758	31,0	1 p.
K23 LFGIC 50.100	7032	50	100	948765	65,0	1 p.
K23 LFGIC 50.150	7032	50	150	948772	86,0	1 p.
K23 LFGIC 50.200	7032	50	200	948789	103,0	1 p.
K23 LFGIC 80.100	7032	80	100	948796	72,0	1 p.
K23 LFGIC 80.150	7032	80	150	948802	100,0	1 p.
K23 LFGIC 80.200	7032	80	200	948819	112,8	1 p.
K23 LFGIC 80.300	7032	80	300	948826	239,5	1 p.

Used for: trunking LFG

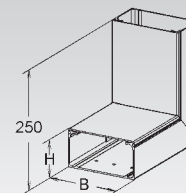

Horizontal elbow 90°

pultruded, with cover

Item ref.	RAL colour	Height mm	Width B mm	EAN code	Weight 100 units pc/m	Min. pack.
K23 LFGWC 40.060	7032	40	60	948901	30	1 p.
K23 LFGWC 50.100	7032	50	100	948918	61	1 p.
K23 LFGWC 50.150	7032	50	150	948925	76	1 p.
K23 LFGWC 50.200	7032	50	200	948932	84	1 p.
K23 LFGWC 80.100	7032	80	100	948949	72	1 p.
K23 LFGWC 80.150	7032	80	150	948956	89	1 p.
K23 LFGWC 80.200	7032	80	200	948963	99	1 p.
K23 LFGWC 80.300	7032	80	300	948970	200	1 p.

Used for: trunking LFG

